

One fluid movement – pipetting for a lifetime

An overview of pipetting techniques,
ergonomics, maintenance and
optimal pipette and tip selection



Leading provider of innovative pipetting systems

You can improve accuracy and precision when you combine the right **pipetting tools, technique, ergonomics, and service** with the most critical factor: the skill and expertise of the operator. Let us show you how with over 50 years of liquid handling experience.



This comprehensive guide will help you achieve better results by providing tips on advancing your pipetting skills so **you can handle anything.**



[View the online guide](#)



History of Thermo Scientific™ liquid handling solutions

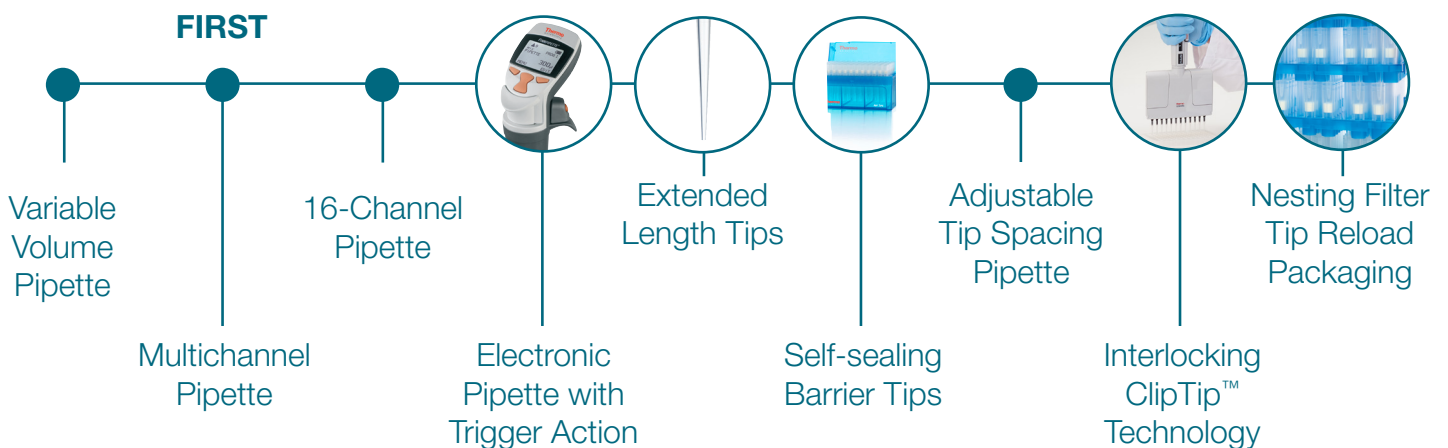

Table of contents

- 4 Liquid handling tool selection**
Choose the best option, from pipette to tip
- 6 Proper pipetting techniques**
Improve your results with proper technique
- 15 Ergonomics**
Ensure your daily environment fits you comfortably
- 25 Maintenance and service**
Secure the quality of your results



Liquid handling tool selection – Choose the best option, from pipette to tip

There are two types of pipettes:

Air displacement pipettes:

Air displacement pipetting is highly accurate for standard pipetting applications. However, temperature and atmospheric pressure, as well as the specific gravity and viscosity of the solution, may affect the performance of air displacement pipettes.

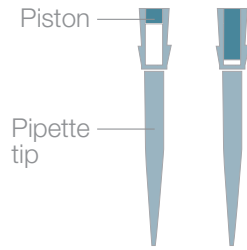

Positive displacement pipettes:

Positive displacement pipetting is based on direct contact of the piston with the liquid. The aspirated liquid amount depends on the dimensions of the cylinder or capillary and the movement distance of the piston. In positive displacement pipettes the tips contain both the cylinder/capillary and the piston.

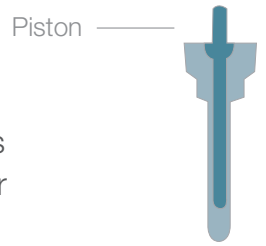

▼ How air displacement pipettes work

▼ How positive displacement pipettes work

Aspirating the liquid (steps 1-3)

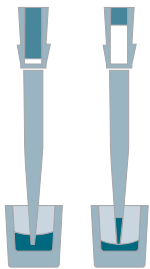

The piston moves to the appropriate position when the volume is set. When the operating button is pressed to the first stop, the piston expels the same volume of air as indicated on the volume setting. After immersing the tip into the liquid, the operating button is released. This creates a partial vacuum, and the specified volume of liquid is aspirated into the tip.



The piston moves down inside the tip to make direct contact with the sample.

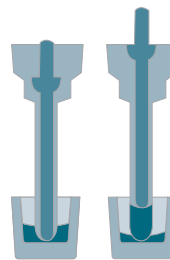

The piston moves up to draw the sample into the tip.

Dispensing the liquid (step 4)

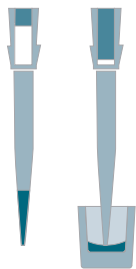

When the operating button is pressed to the first stop again, the air dispenses the liquid. To empty the tip completely, the operating button is pressed to the second stop (blow-out).

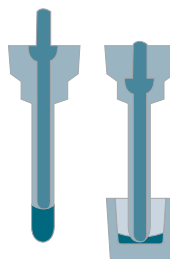

When dispensing, the piston descends and the selected volume is dispensed.

Both pipette types have a piston that moves in a cylinder or capillary. In air displacement pipettes, a certain volume of air remains between the piston and the liquid. In positive displacement pipetting, the piston is in direct contact with the liquid.

Pipette tip selection – Select the correct tip for ideal sample recovery

There is a pipetting system for virtually every application and requirement. The type of experiment you are performing and the physical properties of the liquid will determine the correct pipette tip to use.

Standard tips

A standard tip is a multi-purpose tip for many laboratory applications with a variety of performance requirements that range from high accuracy to reagent dispensing with greater tolerance. Sterile standard tips are available for applications demanding the highest level of purity.

Sterile filter and barrier tips

Cross-contamination from pipetting is a constant concern within a lab. Two options exist within the Thermo Scientific Portfolio: Filter Tips and Barrier Tips. A filter tip utilizes pore size and treacherous path technologies to help control liquid from accidentally splashing the inside of a pipette. An ART Barrier tip utilizes a self-sealing technology to prevent liquid from passing and accidentally splash the inside of a pipette.

Filter and Barrier tips are recommended for low volume applications in genetic studies, forensics and PCR or anytime contamination is a concern.

Extended length pipette tips

Extended length tips allow you to access the bottom of test tubes, reagent bottles, flasks, and other vessels without touching the shaft of the pipette against the side of the tube. This adds a layer of security to protect samples, and virtually eliminates the chance of carryover contamination. The longer tip length allows you to reach the bottom of long or narrow vessels that standard tips cannot reach.

Choosing the correct tip for your application will help in reaching optimal results faster and easier.

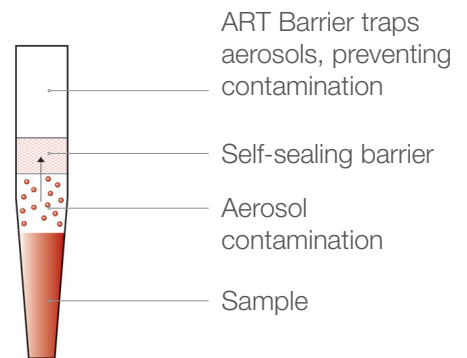

**Thermo Scientific™
ART™ tips -**



▶ Watch how ART Barrier Tips work

Low retention pipette tips

Utilizing polymer technology makes the inner surface of the pipette tip more hydrophobic, resulting in a reduction in sample loss due to adhesion. Benefits include improved sample delivery and conservation of expensive reagents.

Specialty tips

Specialty tips are designed for unique pipetting applications to save time, reduce contamination, and increase accuracy, precision, and productivity.

Wide orifice specialty tips

Wide orifice tips feature a distal end orifice that is nearly 70 percent larger than that of a standard pipette tip. These tips provide the added flexibility required for handling difficult-to-pipette samples. They are designed for researchers working with macromolecules like genomic DNA and are especially critical for transferring fragile cellular samples such as macrophages, hybridomas, and hepatocytes, as well as other viscous materials.

Did you know that we have the broadest selection of pipette tips?



Learn more about Thermo Scientific™ ClipTip™ Pipetting System, Thermo Scientific™ Finntip ART™ tips and others at thermoscientific.com/pipettetips



**Available in certain countries*

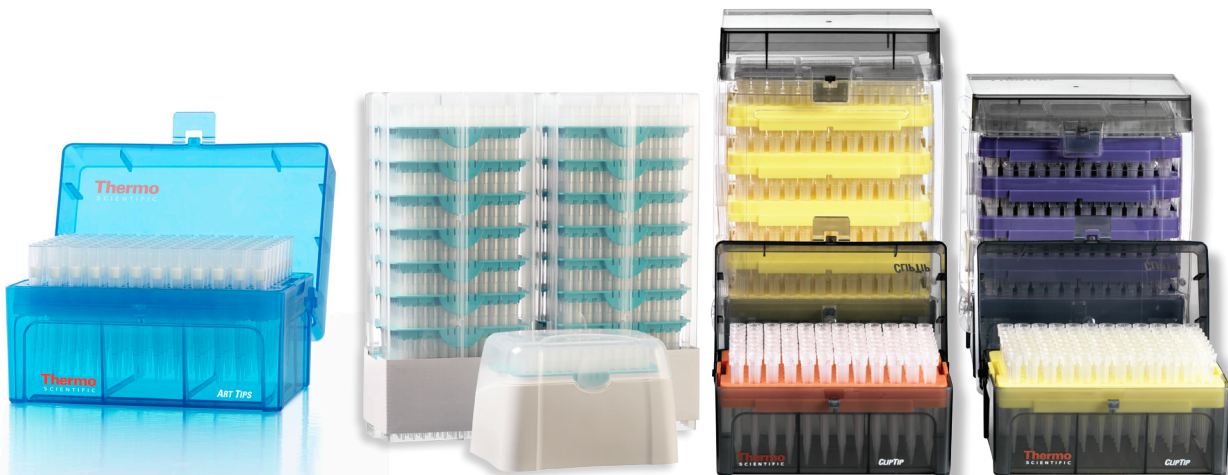

Gel loading specialty tips

Loading acrylamide or agarose gels with standard pipette tips can be a time-consuming process. Use the round gel loading tips for agarose gels and specialized Ultra Round and Ultra Flat gel tips for your polyacrylamide gels to speed up the loading process.

Solvent safe carbon filtered specialty tips

Solvent-safe carbon filtered pipette tips are the best solution for handling the pipetting rigors of Combinatorial Chemistry. These specialized tips keep strong acids, bases, and aggressive organic solvents from causing pipette failures and critical inaccuracies.

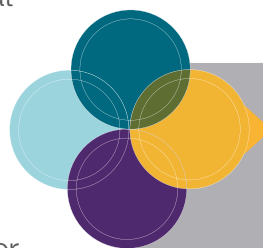

Improve Gel Loading
for PCR Analysis



Visit the online
guide to read the
application note

Genomic (wide orifice)



ART 200G Wide Bore

Extended length



Finntip 1000 EXT

Gel loading



ART 20P Gel Loading

Solvent safe carbon filter



ART 200 Solvent Safe

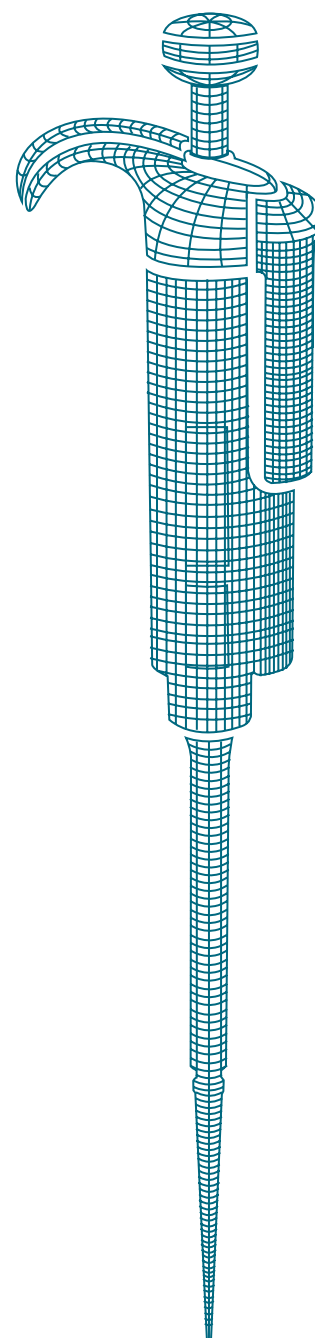

Pipetting in different applications



Thermo Scientific™
Finnpipette™ F1 200 µL
single channel pipette

Due to their versatility and wide volume range, **variable volume air displacement single-channel pipettes** are the most used laboratory instruments. The same pipette can be used for multiple applications.

Multichannel pipettes are most commonly used in microplate applications, such as ELISA, PCR, or cell culture. Manual multichannel pipettes offer instant usability for small scale multichannel work. Multichannel pipettes are available as 8- or 12-channel versions to work with 96-well microplates, and as a 16-channel version to work with 384-well microplates.

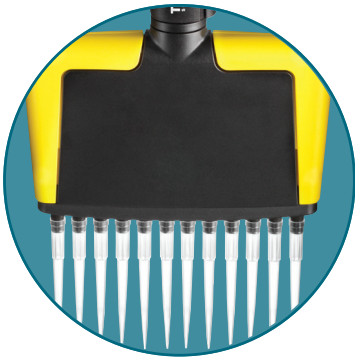

Thermo Scientific™
Finnpipette™ F2 100 µL
12-channel pipette

In applications where a lot of repetitive pipetting is performed, an electronic pipette provides a significant ergonomic benefit. **Electronic pipettes** are versatile laboratory workhorses that can be programmed to perform most laboratory tasks. The most commonly used function of electronic pipettes is the aliquoting of a reagent into multiple doses - multidispensing.

By using a **multichannel electronic pipette** and repeat dispensing modes in microplate filling, the time needed for filling the plate can be reduced from several minutes to less than a minute. Electronic pipettes that offer **adjustable tip spacing** increase efficiency in samples transfers to move several samples at once between different labware formats.



Thermo Scientific™
E1-ClipTip™ Adjustable Tip
Spacing Equalizer 6-ch pipette

Serological pipets are used in cell and tissue culture applications, and in general laboratory liquid dosage when more than 1 ml volumes are pipetted. Serological pipets are made of glass or polystyrene. Plastic, disposable pipets are useful in applications where sterility is a requirement. Serological **Pipet Fillers** help to aspirate and dispense liquids accurately and with precision. The speed of both aspiration and dispensing can be adjusted separately to work with a variety of liquids.



Thermo Scientific™
S1 Pipet Filler

A **bulk reagent dispenser** is a reliable and easy tool for dispensing reagents directly from the reagent bottle.

A dispenser offers speed and accuracy with no extra work steps in everyday liquid dispensing.

Proper pipetting technique – Improve your results with proper technique

For standard pipetting use the Forward Technique:

Recommended for aqueous solutions, such as buffers, diluted acids, or alkalis, this technique is commonly used when pipetting and mixing a sample or reagent into another liquid.

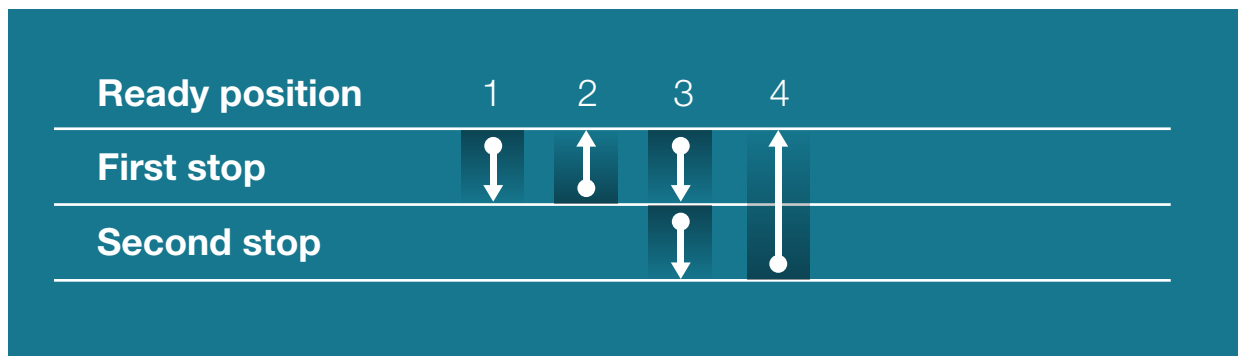

1. Press the operating button to the first stop.
2. Dip the tip into the solution to a depth of 1 cm, and slowly release the operating button. Withdraw the tip from the liquid, touching it against the edge of the reservoir to remove excess liquid.
3. Dispense the liquid into the receiving vessel by gently pressing the operating button to the first stop. After one second, press the operating button to the second stop. This action will empty the tip. Remove the tip from the vessel, sliding it along the wall of the vessel.
4. Release the operating button to the ready position.



Meet your new favorite pipette

Did you know that the FinnpiPETTE Novus Electronic pipettes have one click access to different pipetting techniques?



View the online guide
to watch the video

For solutions with high viscosity or tendency to foam use the Reverse Technique:

This technique is commonly used with air displacement pipettes, and is recommended for precisely pipetting small volumes. Reverse pipetting avoids the risk of sample splash, foaming, or bubble formation.



Are you using more than 5 plates per day? Consider using Thermo Scientific Electronic pipettes, which offer a multidispensing function. This function uses a reverse pipetting technique, making it ideal for accurate and precise plate filling applications.

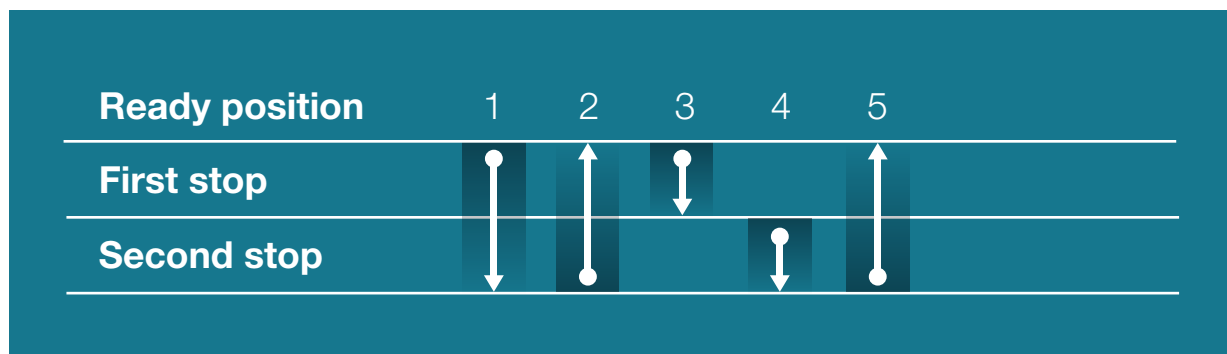

1. Press the operating button to the second stop.
2. Dip the tip into the solution to a depth of 1 cm, and slowly release the operating button. This action will fill the tip. Withdraw the tip from the liquid, touching it against the edge of the reservoir to remove excess liquid.
3. Dispense the liquid into the receiving vessel by depressing the operating button gently and steadily to the first stop. Hold the button in this position. Some liquid will remain in the tip, and this should not be dispensed. Remove the tip by sliding it along the wall of the vessel.
4. The liquid remaining in the tip can be pipetted back into the original solution or thrown away with the tip.
5. Release the operating button to the ready position.

For repeat pipetting of the same volume use the Repetitive Pipetting Technique:

This technique is intended for repeat dispensing of the same volume, and is ideal for adding reagents into tubes or wells of microplates.

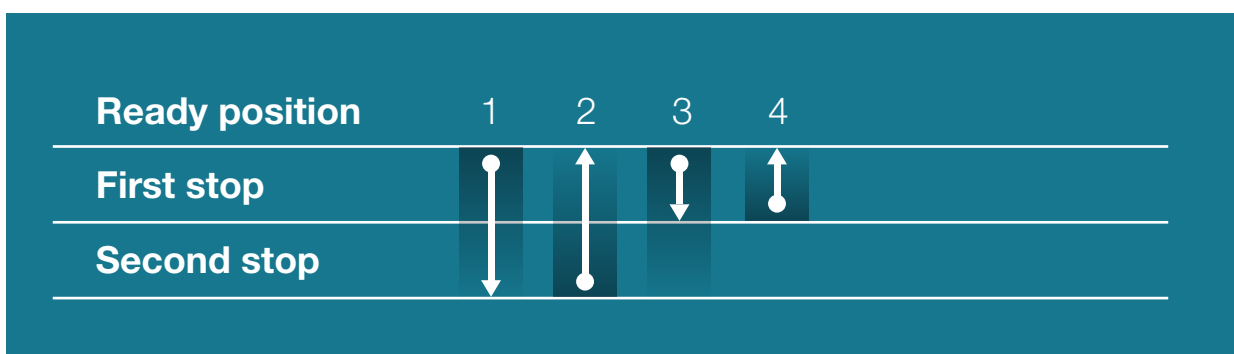

1. Press the operating button to the second stop.
2. Dip the tip into the solution to a depth of 1 cm, and slowly release the operating button. Withdraw the tip from the liquid, touching it against the edge of the reservoir to remove excess liquid.
3. Dispense the liquid into the receiving vessel by gently pressing the operating button to the first stop. Hold the button in this position. Some liquid will remain in the tip, and this should not be dispensed. Remove the tip by sliding it along the wall of the vessel.
4. Continue pipetting by repeating steps 2 and 3.

Heterogeneous Sample Pipetting Technique:

This technique is used for pipetting heterogeneous samples, such as blood or serum. Typically, pre-rinsing the tip is not possible, and the full sample should be dispensed for accurate analysis.

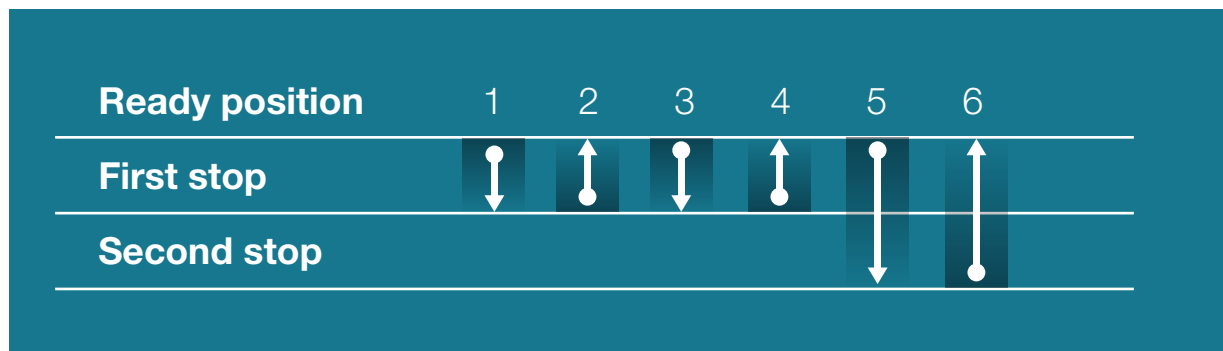

1. Press the operating button to the first stop. Dip the tip into the sample. Make sure the tip is sufficiently below the surface.
2. Release the operating button slowly to the ready position. This action will fill the tip with the sample. Remove the tip from the solution by sliding it along the wall of the vessel.
3. Dip the tip into the target solution. Make sure the tip is sufficiently below the surface.
4. Press the operating button to the first stop and release it slowly to the ready position. Do not remove the tip from the solution. Repeat this process until the interior wall of the tip is clear.
5. Remove the tip from the solution by sliding it along the wall of the vessel. Press the operating button to the second stop, and completely empty the tip.
6. Release the operating button to the ready position.

Recommendations for pipetting liquids

Getting started

- Check your pipette at the beginning of your working day for dust and dirt on the outside. If needed, wipe with 70% ethanol.
- Check that you are using tips in agreement with the manufacturer's specifications. Thermo Scientific pipettes are calibrated using Thermo Scientific pipette tips.
- To ensure accuracy, use only high-quality tips made from contamination-free virgin polypropylene.
- Tips are designed for single use. They should not be cleaned for reuse, as their metrological characteristics will no longer be reliable.
- Pipette parallel samples in a similar way, e.g., pipette in the same position with the tip in the same depth, using the same speed for plunger movements.
- Avoid turning the pipette on its side when there is liquid in the tip. Liquid might get into the interior of the pipette and contaminate the pipette.
- Avoid contamination to or from hands by using a tip ejector for tip removal.
- Always store pipettes in an upright position on a stand when not in use.

Recommendations for pipetting different compounds

Solution/compound	Examples	Pipette	Pipette Tip	Pipetting technique	Comments
Aqueous solution	Buffers, diluted salt solutions	Air displacement	Standard	Forward	
Viscous solution	Protein and nucleic acid solutions, glycerol, Tween 20/40/60/80	Air displacement Positive displacement	Standard or wide orifice, Low Retention Positive displacement	Reverse	Pipette slowly to avoid bubble formation.
Volatile compounds	Methanol, hexane	Air displacement Positive displacement	Filter/Barrier Positive displacement	Reverse	Pipette rapidly to reduce the effect of evaporation. Carbon filter tips protect the integrity of the pipette by eliminating exposure to harmful vapors.
Body fluids	Whole blood, serum	Air displacement	Standard or wide orifice tip	Heterogeneous*	Residual liquid can be found on the outer surface of the tip. Wipe the tip against the edge of the vessel to remove this liquid before dispensing.
Nucleotide solutions	Genomic DNA, PCR products	Air displacement Positive displacement	Filter/Barrier or wide orifice Positive displacement	Forward	For genomic DNA wide orifice tips can be used to eliminate mechanical shearing.
Radioactive compounds	¹⁴ Carbonate, ³ H-thymidine	Air displacement Positive displacement	Filter/Barrier Positive displacement	Forward	
Acids/alkalis	H ₂ SO ₄ , HCl, NaOH	Air displacement	Filter/Barrier	Forward	
Toxic samples		Air displacement Positive displacement	Filter/Barrier Positive displacement	Forward or reverse	

*With blood or serum reverse technique is another option. During the aspiration and dispensing, use very slow plunger movements. When aspirating, hold the tips in the liquid for a few seconds, after the plunger is in the upper position. Also, when dispensing, move plunger slowly and wait a few seconds when plunger is in the down position.



*Thermo Scientific FinnpiPette
Novus Electronic Pipettes*

Improve accuracy with 10 proven steps

1 Pre-wet the pipette tip

Aspirate and fully expel an amount of the liquid at least three times before aspirating for delivery. Failure to pre-wet the tip increases evaporation within the tip air space, which can cause significantly lower delivery volumes. Pre-wetting increases the humidity within the tip, thus reducing evaporation.

2 Work at temperature equilibrium

Allow liquids and equipment to equilibrate to ambient temperature prior to pipetting. The volume of liquid delivered by air displacement pipettes varies with relative humidity and vapor pressure of the liquid – both of which are temperature-dependent. Working at a constant temperature minimizes variation of pipetted volume.

Effect of temperature

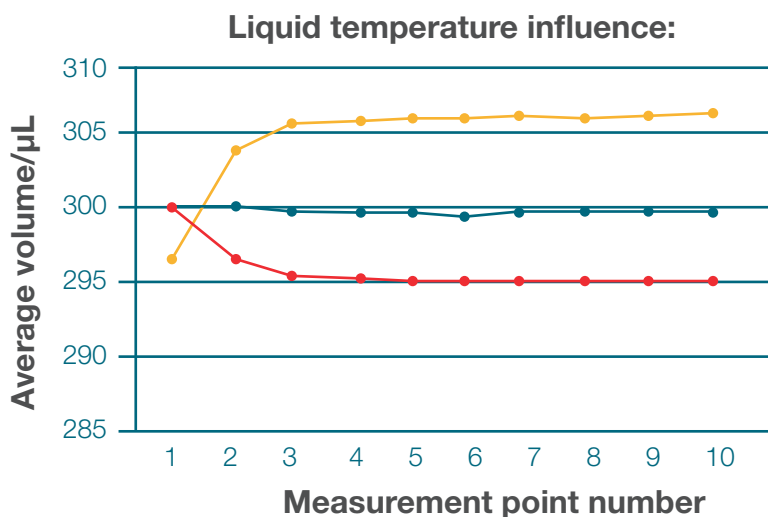

Temperature differences cause thermal expansion and shrinking in the air space. After temperature equilibrium, the influencing factor is liquid density. Cold liquid is more dense and hot liquid is less dense compared to room temperature liquids.

- Room temperature
- 15 °C/59 °F
- 30 °C/86 °F

3 Examine the pipette tip for droplets

Before dispensing, carefully remove droplets from the outside of the tip by touching off the side of the reservoir, being sure to stay clear of the tip opening to avoid wicking liquid out of the tip. After dispensing, and before releasing the plunger, deliver any residual liquid remaining in the tip by touching the tip to the side of the container. Surface tension will help draw the remaining liquid out of the tip.

4 Select forward or reverse pipetting based on the liquid

Depress the plunger to the first stop, immerse the tip into the liquid, and aspirate by releasing the plunger. Remove the pipette from the liquid and depress the plunger to the second stop to dispense the entire contents. Standard (or forward) mode pipetting yields better accuracy and precision than reverse mode for all but viscous or volatile liquids. Reverse mode often results in over-delivery. Hence, it's recommended to evaluate the effect of possible over-delivery in the experiment and make adjustments if needed.

Effect of viscosity

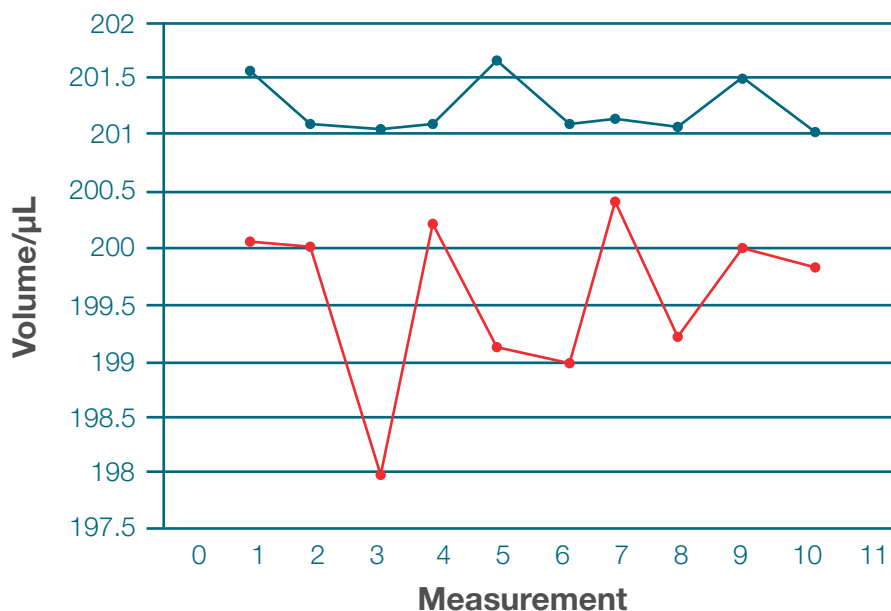

In this experiment 200 µL of viscous liquid (glycerol) was pipetted 10 times by using both forward and reverse pipetting techniques. The pipette used was adjusted for glycerol using forward pipetting. The chart describes the accuracy and precision obtained with both techniques.

Using the reverse method a smaller deviation between doses was observed and therefore reduced imprecision.

The reverse method gave bigger doses as the liquid column in the tip is taller and therefore the liquid amount above the dose presses a larger dose out.

- Forward method
- Reverse method

5 Pause consistently

After aspirating, and before removing the tip from the liquid, pause consistently for 1-3 seconds depending on liquid volume and viscosity. Higher volumes or very viscous liquids will need longer time to stabilize. Liquid continues to flow into the tip for a short time after the plunger stops. At the same time, evaporation within the tip is occurring. Pausing consistently balances these two effects and ensures correct aspiration.

6 Remove pipette straight from vessel

When aspirating liquid, hold the pipette vertically and pull the pipette straight out from the center of the reservoir. This technique is especially important when pipetting small volumes (less than 50 μL). Holding the pipette at an angle as it is removed from the liquid alters the aspirated volume.

7 Minimize handling of pipette and tip

Hold the pipette loosely and utilize the finger rest. Remember to return the pipette to the pipette stand between deliveries. Avoid handling pipette tips or reservoirs with bare hands. Body heat transferred during handling disturbs temperature equilibrium, which leads to variations in delivered volume.

8 Use the correct immersion depth

Before aspirating, immerse the tip adequately below the meniscus. Use consistent depth for same volume aspirations. Too little immersion, particularly with large volume pipettes, can lead to aspiration of air. Too much immersion can cause liquid to cling to the outside of the tip. Contacting the container bottom with the tip may restrict aspiration.

Tip immersion depth and angle

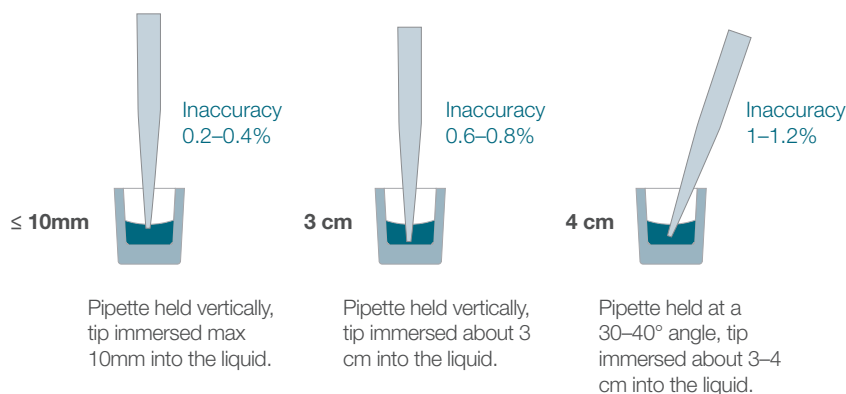

Step 1: The tip is immersed to the correct depth and correctly held vertically.

Step 2: Inaccuracy doubles when immersing the tip too deeply.

Step 3: Inaccuracy increases three to five times by immersing too deeply while holding the pipette at a 30–40° angle.

Effects of immersing the tip too deeply and tilting the pipette are greater with small sample volumes, e.g., using 1–10 μL pipette.

9 Use the correct pipette tip

Use high-quality tips intended for use with the pipette. System tips are designed to work with their matching pipettes. Mismatched tips and pipettes can result in inaccuracy, imprecision, or both. Quality system tips provide an airtight seal, are made of superior materials, and are free of molding defects. They also ensure dependable liquid delivery.

Understanding tip quality

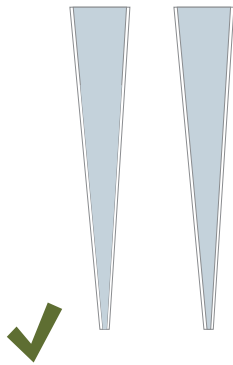

A smooth inner wall will dispense all liquid in a tip.

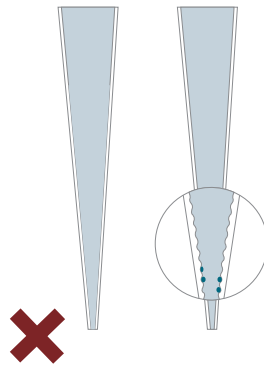

A rough inner wall will hang up liquid in a tip, resulting in poor accuracy/precision.

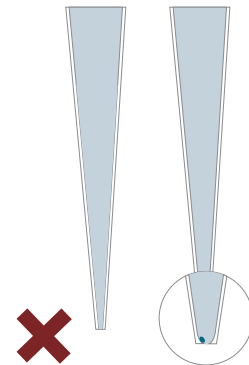

Flash at the orifice can hang up liquid, resulting in poor accuracy/precision.

10 Use consistent plunger force and speed

Depress the plunger smoothly until coming to rest with a light and consistent force at the first stop. Immerse the tip, and then release the plunger at a constant rate. Repeatable actions produce repeatable results.



Did you know it's possible to adjust aspiration and dispensing speeds for each pipetting step separately with E1-ClipTip Electronic pipettes?

Combine this feature with electronic pipetting action to minimize any personal effects on your protocol for optimal and consistent liquid dispensing.



Accurate data. More discoveries.

Accuracy is the quality of being true, correct, exact, and free from error. Accuracy is the ability of a pipette to give a response close to a true or nominal volume as indicated by the volume setting.

Precision is often referred to as repeatability or sample reproducibility, and also as a standard deviation.

Error-free pipetting requires both precision and accuracy. *When pipettes are both accurate and precise the mean volume is the set volume and there is no variation between different pipettings.*

Example: The pipette volume is set at 20 μL .

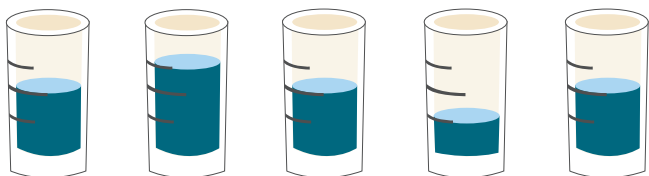

Accurate, but not precise:

The mean volume is the correct (set) volume, but the separate pipettings differ from the set volume.

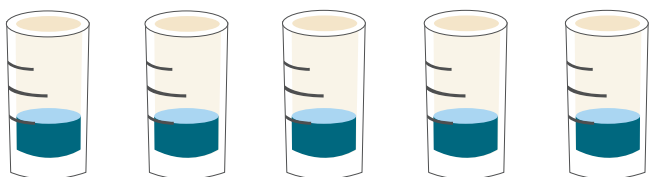

Precise, but not accurate:

There is no variation between the separate pipettings, but the mean volume differs from the set volume.

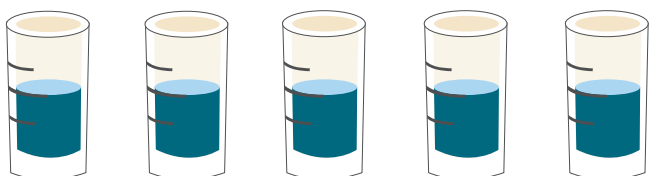

Accurate and precise:

The mean volume is the set volume, and there is no variation between the different pipettings.

Factors affecting the accuracy of air displacement pipettes

Temperature

Temperature has many effects on pipetting accuracy. The factor that has the greatest effect is the temperature difference between the delivery device and the liquid. The air gap (dead air volume) between the liquid surface and the piston experiences thermal expansion effects unique to the case. This either reduces or increases the liquid amount aspirated into the tip, along with other effects.

Density

The density (mass/volume ratio) affects the liquid volume that is aspirated into the tip. A smaller dose of liquid with higher density than water is aspirated compared to a similar operation with water. With lower density liquids the effect is the opposite. This is caused by the flexible dead air volume along with earth's gravity. The density of liquids also varies according to temperature. Typically the density for water is 0.998 kg/dm³, for ethanol 0.79 kg/dm³, and for sulfuric acid (95–98% H₂SO₄) 1.84 kg/dm³ (the values apply at the temperature of 20 °C/68 °F).

Altitude

Geographic altitude affects accuracy through air pressure. Air pressure decreases in higher altitudes, and the conversion factor Z decreases as well. Also, with some liquids, the boiling point decreases quite close to room temperature, which will increase the evaporation loss dramatically.

Ergonomics and pipetting

Pipetting is one of the most common and repetitive activities carried out in life science laboratories across the world. It is important therefore to understand the risks involved and the techniques and tools available to ensure risk is reduced.

Musculoskeletal Disorders (MSD) and Repetitive Strain Injury (RSI)

Ergonomics is “the science of fitting the job to the worker”¹. Poor ergonomics can result in musculoskeletal disorders (MSD) which are injuries to muscles, nerves, tendons, ligaments, joints, cartilage and spinal disks. Repetitive Strain Injury (RSI) is a subset of MSD caused by repetition and excessive force. It can be painful and sometimes permanent. While pipetting we need to be mindful of any pain in the hands, elbows and shoulders.

“Laboratory personnel spend roughly two hours a day on average on pipetting, which amounts to 500 hours a year.” Bjorksten concluded that more than 1.3 hours a day elevated the risk of injury.²

Prevention of RSIs

RSI's are preventable with the use of ergonomic practices and ergonomic tools. In this brochure we provide tips and guidance on good practices and also highlight key Thermo Scientific products designed to reduce risk of injury.

Pipetting risk factors - 4 key areas

- ▶ **Environment** - position surrounding materials to enable proper posture
- ▶ **Posture** - correct positioning of your body by using the correct tools
- ▶ **Force** - reducing the tip attachment, ejection, and pipetting force
- ▶ **Repetition** - limit the number of pipetting motions

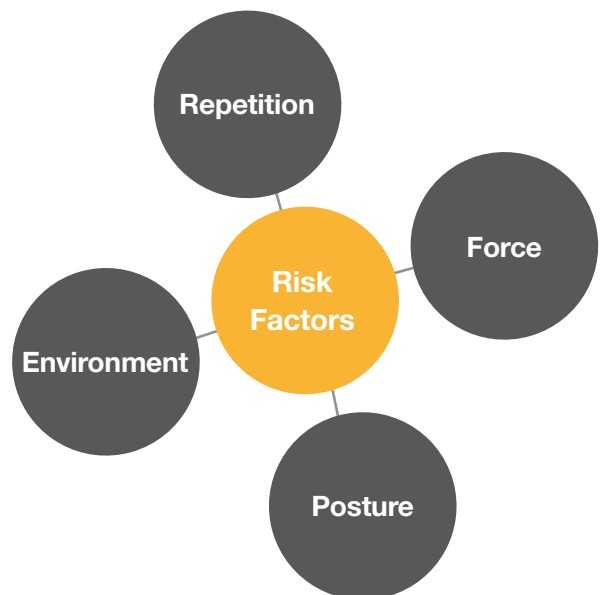

¹Occupational Safety and Health Administrations (OSHA), Federal and State Programs

²Bjorksten, Almy, and Jansson; 'Hand and shoulder ailments among laboratory technicians using modern plunger-operated pipettes' 1994. Thirty minutes of continuous pipetting can cause increased hand complaints: David, Buckle; A questionnaire survey of the ergonomic problems associated with pipettes and their usage with specific reference to work-related upper limb disorders. Applied Ergonomics. 1995; 28 (4): 257-62. Typical laboratories can perform thousands of pipetting operations a day.

Posture and environment

Pipetting is used in a wide variety of applications and work environments. It may be carried out at the bench, in biosafety cabinets, clean environments or other work areas. To help avoid strain it is important to adopt good posture whatever the environment.

Bad posture



Seated posture:

- Shoulders elevated
- Upper arm elevated
- Elbow extended

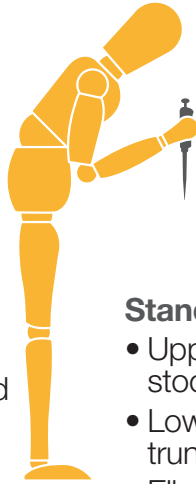

Standing posture:

- Upper back and neck stooped
- Lower back and trunk stooped
- Elbow flexed

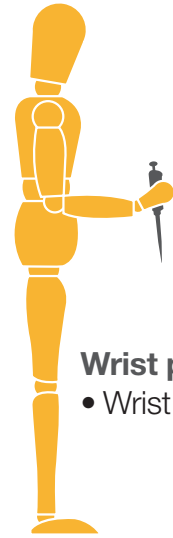

Wrist posture:

- Wrist deviated

Good posture



Seated posture:

- Lower back supported by chair
- Upper back and neck upright
- Elbow bent at 90°
- Wrist in the same plane as the forearm

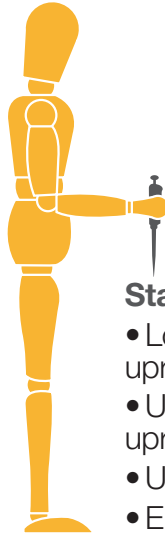

Standing posture:

- Lower back and trunk upright
- Upper back and neck upright
- Upper arm vertical
- Elbow bent at 90°



Wrist posture:

- Forearm parallel to the floor
- Wrist and forearm in the same plane

Eight tips to reduce **risk factors**

- 1 Take micro-breaks of three to five minutes, for every 20-30 minutes of pipetting
- 2 Adjust the workstation so the work can be done with arms close to the body
- 3 Use shorter pipettes
- 4 Use pipettes that fit comfortably in the user's hand
- 5 Keep samples and instruments within easy reach
- 6 Use low profile waste receptacles for used tips
- 7 Use anti-fatigue matting when it's necessary to stand for long periods of time
- 8 Use an adjustable stool or chair when sitting

Force and repetition

Force

Pipetting is a forceful activity. Manual pipetting requires force to attach, depress, hold, aspirate, dispense and eject. It may strain the muscles and joints of the shoulders, forearm, wrist and fingers.

Movements contributing to muscle pain include:

- Tip attachment
- Tip ejection
- Multiple arm/hand movements
- Reaching/stretching with thumb
- Plunger operation
- Gripping the pipette

To help reduce force it is recommended to:

- Clean and grease pipettes on a regularly scheduled basis
- Use pipette tips that fit correctly and are easy to eject
- Use minimal force when applying pipette tips
- Use manual pipettes with light plunger forces
- Choose a pipette that fits comfortably in your hand
- Use electronic pipettes if you use more than five microplates a day
- Minimise thumb strain by using electronic pipettes with index finger action and electronic tip ejection

Repetition

Pipetting is a repetitive activity. Reducing the number of pipetting movements and repetitions will lower any risk of injury.

Tips to reduce repetition include:

- For tasks such as mixing or aliquotting, use an electronic pipette with mixing functions
- Use a multichannel pipette for large aliquotting tasks
- Use 16-channel or 384-format pipettes when working with 384-microplates
- Use electronic pipettes with a multi-dispensing function if you do more than five microplates a day
- Store programs for your most used protocols on your electronic pipette
- When transferring samples between different labware formats use adjustable tip spacing pipettes instead of single channel pipettes
- Avoid unnecessary rework by preventing tips from falling off or leaking by using pipette and tips designed and manufactured as a system
- Consider an automated liquid handling device or reagent dispenser if you do 10-50 microplates a day

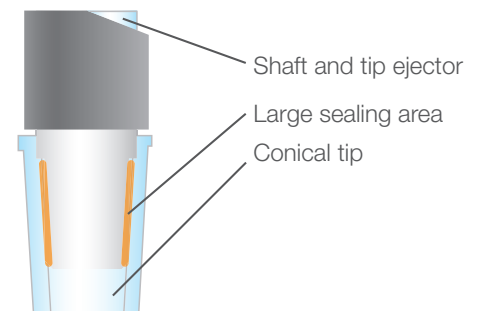
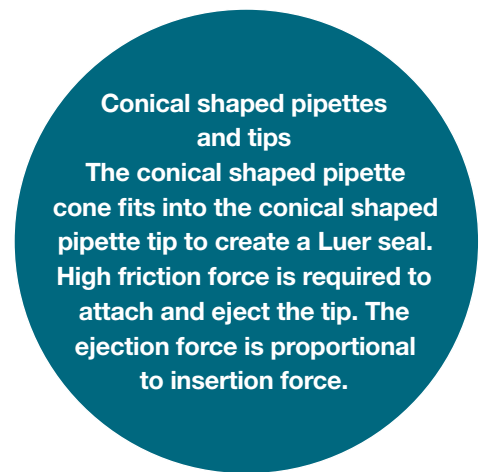

Thermo Scientific pipetting systems

Optimal ergonomic comfort and technical excellence is best achieved when pipettes and tips are designed to work together as one system. Thermo Fisher Scientific offer two pipetting systems:

Thermo Scientific ClipTip Pipetting System

The ClipTip Pipetting System uses interlocking technology both to attach tips securely and eject easily all with minimal force.

The system includes:

- F1-ClipTip Manual Pipettes
- E1-ClipTip Electronic Pipettes
- E1-ClipTip Equalizer Electronic Pipettes
- ClipTip Pipette Tips



Thermo Scientific Finnpipette Pipetting System

Ergonomically designed Thermo Scientific™ Finnpipettes™ and Thermo Scientific Finntip Flex Tips used together provide a friction fit system with high comfort and precision.

The system includes:

- Finnpipette F1 Manual Pipettes
- Finnpipette F2 Manual Pipettes
- Finnpipette Novus Electronic Pipettes
- Finntip and Finntip Flex™ Pipette Tips



Thermo Scientific Pipetting Systems at a glance

System Feature	ClipTip Pipetting System			Finnpipette Pipetting System		
	F1-ClipTip Manual Pipettes	E1-ClipTip Electronic Pipettes	E1-ClipTip Equalizer Electronic Pipettes	Finnpipette F1 Pipettes	Finnpipette F2 Pipettes	Finnpipette Novus Electronic Pipettes
Calibrated with and exclusively uses ClipTip tips	x	x	x			
Calibrated and recommended to use with Finntip or Finntip Flex Tips				x	x	x
Secure interlocking tip attachment	x	x	x			
120° adjustable finger rest	x	x	x	x		x
Silent locking volume adjustment	x			x		
Fully autoclavable					x	
Electronic index finger pipetting		x	x			x
Electronic tip ejection		x	x			
Adjustable tip spacing			x			
Rotating LCD display		x	x			
User friendly interface		x	x			x
Programmable		x	x			x
My Pipette Creator programming		x	x			
Recommended throughput plates/day*	< 5	5 - 10	5 - 10	< 5	< 5	5 - 10

* To fill more than 10 plates a day consider the Thermo Scientific™ Multidrop™ Combi or Thermo Scientific™ Pico™ Reagent Dispenser

Reducing force ClipTip pipetting system

Sealed in security - feel the difference

Thermo Scientific ClipTip pipettes work exclusively with Thermo Scientific ClipTip Pipette Tips to create this leading ergonomic system. Thermo Scientific ClipTip technology provides a non friction system to help reduce risk of strain injuries¹.

- Extremely low tip attachment and ejection forces
- Comfortable to use and with a light touch
- Complete seal on every channel with no loose tips
- Reproducible results every time and between users

See it in action at thermofisher.com/cliptip

¹ Thermo Scientific Application Note: ClipTip Technology Part 3 - Reduce the Risk of Repetitive Strain Injury (RSI), 2013

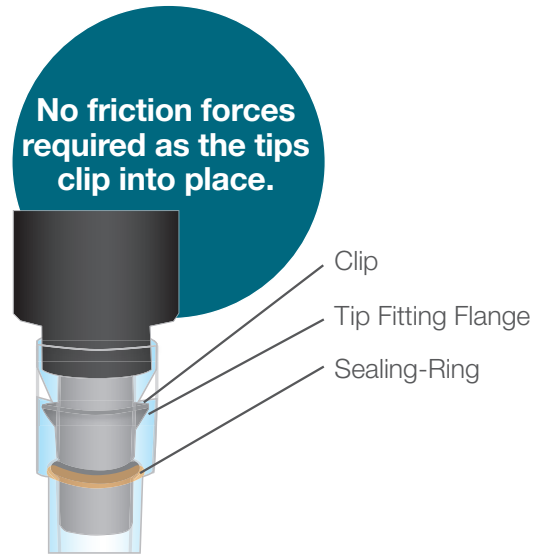

F1-ClipTip manual pipettes

Minimal tip attachment and ejection force

A unique combination of ergonomic pipette design and ClipTip Pipette Tips provides a pipetting system that optimises user comfort, safety and pipetting consistency.

Learn more about our range of ClipTip pipettes and tips at thermofisher.com/cliptip



Adjustable comfort

120° adjustable finger rest.

Silent, effortless volume adjustment

The ergonomic locking volume adjustment knob enables effortless and precise adjustment.

Industry-leading lifetime warranty

With convenient online registration at thermofisher.com/pipettewarranty.

ClipTip technology

A secure seal on every channel with low attachment and ejection forces.



Reducing repetition

E1-ClipTip electronic pipettes

Repeated, daily, manual pipetting, especially between multiple labware formats, requires a high number of pipetting motions. Switching from manual to electronic pipettes or automated dispensers can significantly reduce repetition, improve comfort

Enjoy pipetting again

Pipetting can be a comfortable, safe and enjoyable experience and your thumb can relax again with the combined ergonomic elements in our Thermo Scientific E1-ClipTip Electronic Pipettes:

- Thermo Scientific ClipTip interlocking tip attachment
- Electronic index finger pipetting action and electronic tip ejection to minimise strain
- Adjustable finger rest optimises comfort for both left and right-handed users
- Rotating display offers neutral pipetting position in any environment.
- Multidispensing functionality reduces repetition



E1-ClipTip equalizer pipettes

A perfect choice for sample transfers between various labware formats

With the Thermo Scientific E1-ClipTip Equalizer Pipettes featuring adjustable tip spacing, sample transfers between virtually any tube, rack, microplate, or horizontal gel box can be performed easily. Adjustable tip spacing allows you to set the distance between tips simply by sliding the scale to expand and contract to your desired setting. This means fewer repetitions for multiple applications.

- 87% lower tip attachment forces and up to 93% lower tip ejection forces compared to other adjustable tip spacing pipettes¹
- Over 80% time savings and fewer repetitions compared to single channel pipettes²



A two year warranty is available on E1-ClipTip pipettes.

¹ Thermo Scientific Smart Note. Tip attachment and ejection force vary significantly among different adjustable tip spacing pipette brands. 2016.

² Compared to a manual single channel pipette filling a 96-well microplate from microcentrifuge tubes. See Thermo Scientific Smart Note: *Is there an easier and more efficient way to transfer liquids between various labware formats, than using traditional handheld pipettes?* 2014.

Reducing force

Finnpipette F1 manual pipettes

Exceptional comfort, redefined

Lightweight handle design combined with low plunger, tip attachment and ejection forces help reduce the risk of RSI when working with our Thermo Scientific Finn timer F1 Manual Pipettes.

Adjustable comfort

The 120° adjustable finger rest – for both right- and left-handed operator comfort.

Optional handle strips for your F1 pipette also enable a firmer grip that makes a huge difference in your work.

Comfortable tip ejection

Soft touch tip ejection combined with the softer collar of Finntip Flex tips reduces ejection forces.

Silent, effortless volume adjustment

Silent and light volume adjustment. Improved grip on the locking volume adjustment knob enables effortless and precise adjustment.

A wider tip ejector gives your thumb more room to operate in comfort.

You benefit from a five year warranty with manual Finn timer pipettes.

Find out more at [thermofisher.com/pipettewarranty](https://www.thermofisher.com/pipettewarranty)



Finntip Flex pipette tips

Perfect ergonomic fit with your Finn timer

Thermo Scientific Finntip Flex™ Pipette Tips work with Thermo Scientific Finn timer Pipettes™ to ensure optimal ergonomics and pipetting accuracy and precision. Tips have a soft collar that flexes to reduce pipetting forces. Compared to other brands, the Finntip Flex tips provide the lowest ejection force with Thermo Scientific Finn timer F1 Multichannel Pipettes¹.

The hinged lid on the Finntip Flex tip rack allows easy one-handed use while the stable rack base design with rubber feet prevents the rack from sliding improving stability and consistency of tip attachment.



1. Thermo Scientific™ Application Note 'Improved Ergonomics based on pipette tip selection'

Reducing repetition

Finnpipette Novus electronic pipettes

Safe and comfortable

Electronic pipetting operation and adjustable speed make the Thermo Scientific Finn timer Novus Electronic Pipettes ideal when working with small volumes and viscous liquids.

The combination of its lightweight design and soft-touch tip ejection makes Novus pipettes the safe and comfortable choice for heavy-duty pipetting applications. Index-finger operation allows your thumb to relax during pipetting.

Easy to learn, program and use, the The Novus STEPPER function allows the repeated dispensing of one selected volume. It's ideal for microplate applications - reducing hand movements and risk of strain.



Finnpipette F2 manual pipettes

Sleek, durable and fully autoclavable

The design is very ergonomic and comfortable for long-term, repetitive sample allocation. Useful colour coding based on volume size is available. All Thermo Scientific Finn timer F2 Pipettes are fully autoclavable reducing risk of contamination and repetitive re-work.



Learn more at thermofisher.com/finnpipette

Improving throughput

Multidrop Combi reagent dispensers

Effortless microliter dispensing

Thermo Scientific™ Multidrop™ Combi Reagent Dispensers offer the ergonomic solution to multiple plate filling.

- Virtually no manual effort required
- Fill plates in seconds
- Easy to use
- Excellent precision and reproducibility
- High throughput
- Choice of dispensing cassette



There are two different Multidrop Combi models available. Find the best dispenser for your needs

System features	Multidrop Combi and Multidrop Combi SMART	Multidrop Combi nL
On-board interactive colour touch screen	Yes	Yes
Volumes	0.5-2500 µL	50 nL-50 µL
Plate formats	6-1536 well plates; including 96-, 384 tubes in rack format	96-1536 well plates; including 96-, 384 tubes in rack format
Plate height adjustment	Automatic	Automatic
Cell dispensing	Yes	Yes
Plate filling format	Rows, columns	Rows, columns, discrete wells

The comprehensive line of Thermo Scientific Multidrop dispensing cassettes offers optimal solutions for a wide volume range and a variety of reagents for the best performance and results. The autoclavable Multidrop dispensing cassettes come with different tubing size, and tip material and size. Choose between standard and small tube cassettes, or SMART versions of these, which store dispensing lifetime data. Dispensing cassettes are available as single versions, 5-packs and 10-packs for different throughput needs.

To learn more visit [thermofisher.com/multidrop](https://www.thermofisher.com/multidrop)

Achieving picoliter precision

Multidrop Pico 1 and Pico 8 digital dispensers

Miniaturize assays with precise, picoliter dispensing

Thermo Scientific Multidrop Pico™ 1 Digital Dispensers and Thermo Scientific Multidrop Pico 8 Digital Dispensers offer enhanced dispensing precision with volumes between 11 pL to 10 µL in any well, eliminating the need for manual dilution while providing significant cost and waste reductions.

- Assay miniaturisation dispensing down to 11 pL
- High throughput with typical dose experiments in 15 seconds
- Decrease hand pipetting steps
- Non-contact disposable dispensing heads to avoid contamination
- Simple assay set up with PicoIT intuitive software
- Dispense any volume in any well at any time
- Complete traceability as PicoIT software tracks dispensing

Multidrop Pico 8 system dispenses up to eight reagents when used with a single 8-well cassette

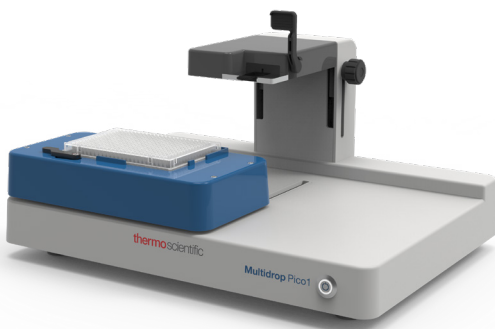

Multidrop Pico 1 Digital Dispenser

- Uses 1-well cassettes to dispense single reagents



Multidrop Pico 8 Digital Dispenser

- Uses 8-well and 4-well cassettes to dispense up to eight and four reagents respectively

Intuitive qPCR set-up

An easy-to-use Multidrop PicoIT software platform with application-focused wizards and a highlighted loading guide allows effortless and quick plate set-up and operation.

The pre-programmed protocols provide:

- Pre-selected fluid information
- Simplified layout including Non-Template Controls (NTCs)
- Pre-set reaction volume and plate type
- Pre-set number of replicates

To learn more, visit [thermofisher.com/digitaldispenser](https://www.thermofisher.com/digitaldispenser)

Maintenance and service – Secure the quality of your results

Tailored solutions to fit your unique needs: Pipette Calibration, Preventive Maintenance, and Repair Services

Pipette cleaning

We make it easy for you to maintain pipette performance over time, and to demonstrate GLP/GMP compliance by offering fast, expert-level calibration, preventive maintenance, and repair services for all Thermo Scientific pipettes, and for most other brands as well. Experienced service personnel are highly trained in all pipette models. We offer both standard and custom service packages to meet the needs of individual customers, and in most major markets we have the ability to bring our calibration, preventive maintenance, and repair services (minor repairs) directly to your facility. (Note: On-site service availability varies between countries. Minimum quantities apply, please check website for details).



To learn more about Pipette Support Plans in your region, contact your local sales representative, or visit [thermofisher.com/equipment-service](https://www.thermofisher.com/equipment-service)



Defining calibration and preventive maintenance

Calibration of pipettes means determining the difference between the dispensed volume and selected volume. Adjustment means altering the pipette so the dispensed volume is within the specifications.

Calibration of pipettes in a quality system

The main objective of pipette calibration in a quality system is to ensure that dispensing is carried out with the intended accuracy and precision. Very often the error limits are taken from the manufacturer's specifications, although far less accuracy is needed to perform the task. It should be kept in mind that in a laboratory environment (uncontrolled) the manufacturer's specifications may not be achieved. Therefore, every user should define their own acceptance limits, according to the application and the ambient conditions. Another option is to use the acceptance limits stated in the standards, for example, EN ISO 8655 multiplied by two. The actual standard specifications—and if the highest accuracy is needed, the manufacturer's specifications—should be used only when testing can be performed in a controlled environment using distilled or deionized water.

Procedure to check calibration

The pipette is checked with the maximum volume (nominal volume), and the minimum volume, and/or 10 percent of the maximum volume, whichever is higher. For example, Thermo Scientific E1-ClipTip 0.5-12.5 μ L pipette is tested at 12.5 μ L and 1.25 μ L. A new tip is first pre-wetted 3–5 times and a series of 10 pipettings is performed with both volumes. Multichannel pipettes are tested with a multichannel balance that enable testing of all channels (up to 12-ch) simultaneously. These balances are normally found in service centers specialized in pipette calibration. Alternatively if multichannel balance is not available, it is possible to test each channel individually, one after another, with a single-channel balance while the volumes from all other channels are discarded. A pipette is always calibrated for delivery (EX) of the selected volume. If the calculated results are within the selected limits, the adjustment of the pipette is correct.

Maintenance intervals

Service intervals vary depending on how often the pipette is used and the liquids that are pipetted. Below are guidelines for frequency of servicing your pipette.

Daily service procedure

It is recommended that the pipette be checked at the beginning of each day for dirt and dust. To clean a dirty pipette, wipe the surface with a sponge moistened with disinfectant. Particular attention should be paid to the tip cone, which tends to come into contact with the pipetted liquid. The handle does not require further service and should not be immersed in disinfectant.

Pipettes should always be stored in an upright position to prevent residual liquid from entering into the tip cone. A pipette stand is ideal for this purpose.



Did you know we have service reminders?

You can set your E1-ClipTip Electronic Pipettes service and calibration reminders or we will send email reminders for your selected times when you register online for extended warranties.



Periodic service procedures

If the pipette is used daily, it should be cleaned and lubricated at least every three months. The service procedure starts with the disassembly of the pipette. Detailed instructions for the disassembly can be found in the Instructions for Use. The calibration must always be checked after cleaning. Some chemicals, such as organic solvents, affect certain parts of the pipette. Therefore, when pipetting these chemicals frequently, special attention should be paid to service.

Vapors from organic solvents may cause the O-rings to swell. When pipetting organic solvents frequently, open the lower part of the pipette and leave it open overnight to ensure proper airing. The O-rings should also be checked and lubricated weekly, and replaced if necessary to prevent leaking. Aerosols from acids and alkalis, on the other hand, affect greasing. Therefore, when pipetting acids and alkalis frequently, it is important to lubricate the piston, piston spring, and the O-rings regularly. Do not use any lubricant to grease the pipette other than the one provided with the pipette.

Filter tips are the best way to keep your pipette clean and protect both your pipette and the sample from contamination. The filter prevents aerosols as well as excess liquids or foreign particles from entering the pipette.

Formulas for calculating results

Conversion of mass to volume

$$V = (w + e) \times Z$$

V = Volume (μL)

w = Weight (mg)

e = Evaporation loss (mg)

Z = Conversion factor for mg/ μL conversion

Evaporation loss can be significant with low volumes. To determine mass loss, dispense water into the weighing vessel, note the reading, and begin timing with a stop watch.

Check how much the reading decreases during 30 seconds. Compare this to the pipetting. Typically, the pipetting time might be 10 seconds and the mass loss is 2 mg. If an evaporation trap or lid on the vessel is used, an evaporation correction is unnecessary.

The conversion factor Z is for calculating the density of water suspended in air at a test temperature and pressure.

Accuracy (systematic error)

Accuracy is the difference between the dispensed volume and selected volume of a pipette.

$$A = V - V_0$$

A = Accuracy

\bar{V} = Mean volume

V_0 = Target volume

Accuracy can be expressed as a relative value:

$$A\% = 100\% \times A/V_0$$

Precision (random error)

Precision refers to the repeatability of the pipettings. It is expressed as standard deviation(s) or coefficient of variation (cv). In addition to the features of the pipette, laboratory practice and user experience are the main factors that affect precision.

$$s = \sqrt{\frac{\sum_{i=1}^n (V_i - \bar{V})^2}{n - 1}}$$

s = Standard deviation

\bar{V} = Mean volume

n = Number of measurements

v_i = Single measurement result ($i = 1 \dots n$)

Standard deviation can be expressed as a relative value as cv.

$$CV = 100\% \times s/\bar{V}$$



READ MORE about the benefits of routine pipette preventive maintenance and calibration



Did you know that it's possible to create liquid specific calibrations with the E1-ClipTip electronic pipette?



Decontamination guidelines

Definitions*

- **Decontamination** – Any process for removing and/or killing microorganisms. The same term is also used for removing or neutralizing hazardous chemicals and radioactive materials.
- **Disinfection** – A physical or chemical means of killing microorganisms, but not necessarily spores.
- **Sterilization** – A process that kills and/or removes all classes of microorganisms and spores.

Pipette cleaning

Cleaning requirements depend on the pipette used and the liquid. The chemical compatibility of the pipette should be checked prior to cleaning. When necessary, protective clothing, goggles, and disposable gloves should be worn.

Table 1. *Cleaning guidelines for Thermo Scientific manual pipettes. See Instructions for Use for Electronic Pipettes guidelines.*

Pipetted liquids	Cleaning guidelines
Aqueous solutions and buffers	Open the pipette, rinse the contaminated parts thoroughly with distilled water, and allow to dry.
Acids and alkalis	It is advisable to clean the tip cone and lower part of the tip ejector with distilled water more frequently if acids or alkalis are handled. Clean as described in "Aqueous solutions and buffers."
Organic solvents	Immerse the contaminated parts in a detergent solution such as Deconex® 12 Basic. Rinse thoroughly with distilled water and allow to dry.
Radioactive solutions	Open the pipette and place the contaminated parts in a strong detergent or cleaning solution. Rinse several times with distilled water and allow to dry. Decontamination should always be followed by confirming that radioactivity has been reduced to an acceptable level. All used cleaning materials are radioactive waste and must be disposed of according to regulations.
Proteins	Open the pipette, immerse the parts in a detergent solution, such as Deconex® 12 Basic. Rinse well with distilled water and allow to dry.
DNA, RNA	DNA can be eliminated by immersing pipette parts in at least 3% (w/v) sodium hypochlorite for at least 15 minutes (2, 3). Rinse well with distilled water and allow to dry. Treat the pipette parts with Thermo Scientific DNA AWAY Surface Decontaminates according to instructions. Exposure to ultraviolet (UV) light for 30–60 minutes will further reduce but not completely eliminate DNA contamination on the pipette surface (4). No special treatment is required to remove RNA because it degrades rapidly and is sensitive to ubiquitous RNases.
DNase, RNase	RNase can be removed by first cleaning the pipette with a detergent solution, followed by thoroughly rinsing with water and then 95% ethanol to speed the drying process. Pipette parts are then soaked in a 3% hydrogen peroxide solution for 10 minutes. Finally, the parts are rinsed thoroughly with DEPC-treated water (5) and allowed to dry. Treat the pipette parts with Thermo Scientific RNase AWAY Surface Decontaminates according to instructions. DNase can be destroyed by autoclaving (15 min., 121 °C/250 °F).
Viruses, mycoplasma, bacteria, and fungi	Ultraviolet (UV) radiation is a practical method for inactivating viruses, mycoplasma, bacteria, and fungi. If the inner parts of the pipette are exposed to UV light, make sure the piston and O-rings are sufficiently lubricated.

Before assembling the pipette, wipe the piston with 70% ethanol and lubricate with the lubricant that is provided with the pipette. When removing RNase, use a freshly opened ethanol bottle and prepare 70% ethanol in DEPC treated water.

Pipette sterilization

Autoclaving is the simplest sterilization method if all pipette parts tolerate extreme heat. Pipettes should be autoclaved according to the manufacturer's instructions. To achieve sterility, a holding time of at least 20 minutes at 121°C (252°F) is required.

- Fully autoclavable FinnpiPETTE F2 and Digital manual pipettes
- Autoclavable tip cones: F1-ClipTip, FinnpiPETTE F1, F3, and Novus pipettes (see Instructions for Use).

All Thermo Scientific manual pipettes can be sterilized with STERRAD® and ethylene oxide treatments. The pipette should be disassembled before the sterilization treatment.

* Definitions comply with the WHO Laboratory biosafety manual (1).

Chemical disinfection and sterilization

Chemical disinfectants or sterilants are used to decontaminate surfaces and equipment if autoclaving is not possible or practical. The choice of a chemical disinfectant or sterilant depends on the microorganisms of concern. Also, the chemical compatibility of the materials should be taken into account. Examples of chemical disinfectants or sterilants are listed in Table 2.

If the lower tip cone and the tip ejector of a pipette have to be chemically decontaminated, the pipette should be disassembled according to the Instructions for Use.

Table 2. *Examples of chemical disinfectants and sterilants*

	Disinfection time (at 20°C/68°F)	Sterilization time (at 20°C/68°F)
Hydrogen peroxide (7.5%)	30 minutes	6 hours
Glutaraldehyde (2.5%)	20–90 minutes	10 hours
Sodium hypochlorite (5%)	20 minutes	N/A
Ethanol (70%)	10–30 minutes	N/A

Preventing cross-contamination

Pipette-to-sample

A contaminated pipette or contaminated tips can cause contamination of samples.

Prevention:

Use filter tips.

Change the tip after pipetting each sample.

Clean the pipette regularly.

Sample-to-pipette

Samples or aerosols from samples can enter the cone of the pipette.

Prevention:

Keep the pipette vertical when pipetting in order to prevent liquid from running into the pipette body.

Release the push button slowly.

To avoid aerosol contamination, use filter tips or use a positive displacement pipette and tips.

Sample-to-sample (carry-over)

The remains of a sample can mix with the next sample inside the tip and may cause a false test result.

Prevention:

Change the tip after each sample.

If you suspect your pipette is contaminated, clean with a suitable method, and autoclave if needed.

References

1. World Health Organization, 2004. Laboratory biosafety manual. 3rd edition. Geneva, Switzerland.
2. Kemp, B.M. and D.G. Smith, 2005. Use of DNase to eliminate contamination in ancient DNA analysis. *Forensic Sci. Int.* 10 (154), pp. 53-61.
3. Prince, A.M. and L. Andrus, 1992. PCR: How to kill unwanted DNA. *Biotechniques* 12 (3), pp. 58–60.
4. Cone, R.W. and M.R. Fairfax, 1993. Protocol for ultraviolet irradiation of surfaces to reduce PCR contamination. *Genome Research* 3, pp. S15–S17.
5. Sambrook, J., E. F. Fritsch and T. Maniatis, 1989. Extraction and purification of RNA. In: *Molecular Cloning – A Laboratory manual*, 2nd edition. Cold Spring Harbor Laboratory Press, New York.

Links

“Lab Workers - Take the Pain Out of Pipetting,” Published by California Dept of Health Services, Occupational Health Branch. Available at <http://www.cdph.ca.gov/programs/hesis/Documents/labwork.pdf>

“Reducing the Risk of Musculoskeletal Injury in Healthcare Laboratory Technologists Performing Pipetting Tasks,” Published by Occupational Health & Safety Agency for Healthcare, British Columbia. Available at <http://www.phsa.ca/Documents/Occupational-Health-Safety/ProjectUpdateReducingtheRiskofMusculoskeletalInjur.pdf>

“Tips for Pipetting,” Published by UCLA Environment Health and Safety. Available at <http://ergonomics.ucla.edu/laboratory-ergonomics/tips-for-pipetting.html>

Enable the smart lab

Focus on doing the science you need to do. The way you want to do it. Making it easier to do your job, lower costs, and get your results faster. We think that's smart.



For more information on Thermo Scientific Liquid Handling Solutions to enhance your daily pipetting visit: thermofisher.com/pipettingforlifetime

Protecting your investment

For more than 25 years, we have prided ourselves by offered qualityminded service that meets customers diverse needs.

Whether you're working in a unique environment such as cGLP, cGMP, critical research, academia, or have a special requirement, you can feel confident that your pipettes will have the accuracy and performance you need.

We provide you with:

- Online visibility of service status, calibration history, and asset management
- Tailored solutions to fit your unique needs
- Option to send pipettes to our calibration laboratory or have us come to your site

Let our expertise complement yours

Explore all the new ways to protect your instruments and equipment at

thermofisher.com/equipment-service



Support Plans | Parts and Consumables | Training and More



warranty registration

Register your pipette online for a free warranty at thermofisher.com/pipettewarranty

© 2016 Thermo Fisher Scientific Inc. All rights reserved. Specifications, terms and pricing are subject to change. Not all products are available in all countries. "STERRAD" (Ethicon) is a trademark of their respective owners. All other trademarks owned by Thermo Fisher Scientific or its subsidiaries. Please consult your local sales representative for details.

thermo scientific

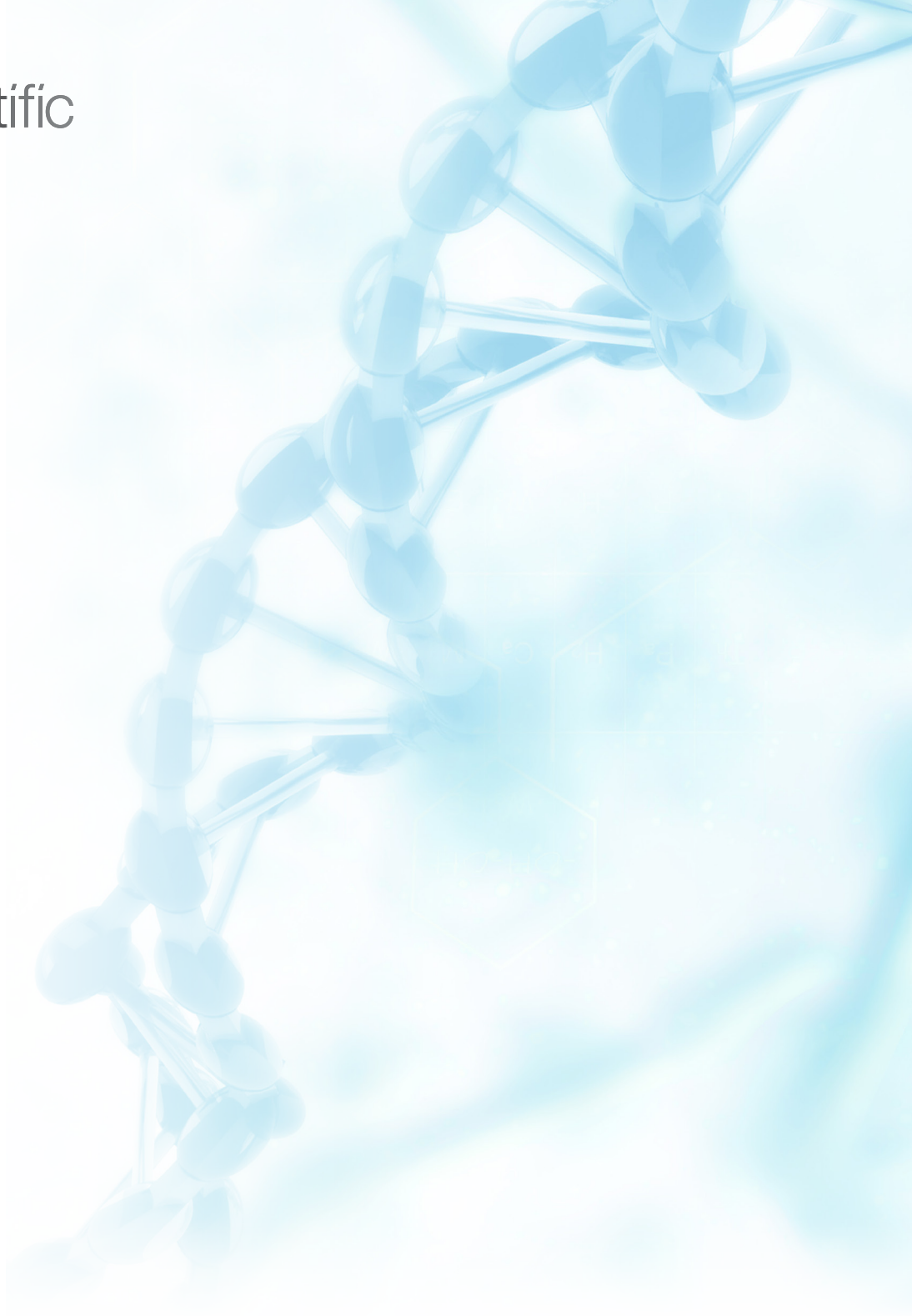

Find out more at thermofisher.com/liquidhandling

© 2021 Thermo Fisher Scientific Inc. All rights reserved. All trademarks are the property of Thermo Fisher Scientific and its subsidiaries unless otherwise specified. Specifications, terms and pricing are subject to change. Validity of lifetime warranty varies by country. Not all products are available in all countries. Please consult your local sales representative for details. **EXT1197**

ThermoFisher
SCIENTIFIC